

# MBTD-SERIES MOISTURE ANALYZERS



**MBTD** moisture analyzers are hi-tech measuring instruments intended for quick determination of relative moisture content, dry mass content and other parameters in samples of different substances.

**MBTD-Series is equipped with innovative system: the drying chamber can be opened and closed automatically using button or proximity sensors.**

## Highlights of MBTD-Series moisture analyzer:

- Automatically opened drying chamber
- Automated drying process
- **DRYING FORECAST** – Prognosis of the Drying Process

## Result

- Modern interface
- Touchscreen
- Programmable display
- Easy configuration of information arrangement
- Wide range of databases – work optimization
- Databases – security and archiving of your work results
- USB interface allowing export of results and databases
- E2R software allowing on-line control over your work

## Interface

### Hot-Keys

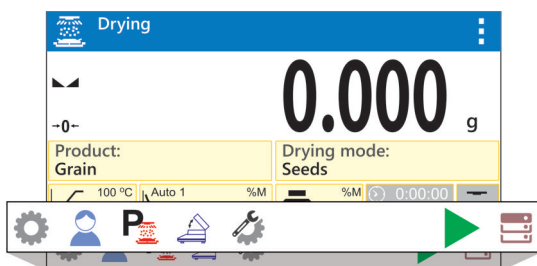

### Labels and information fields

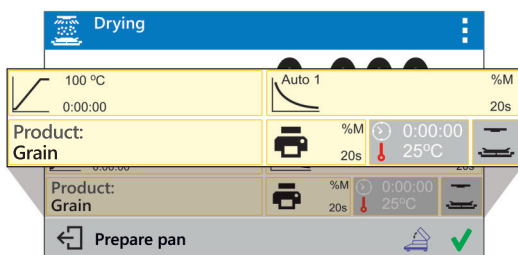

### Functions keys

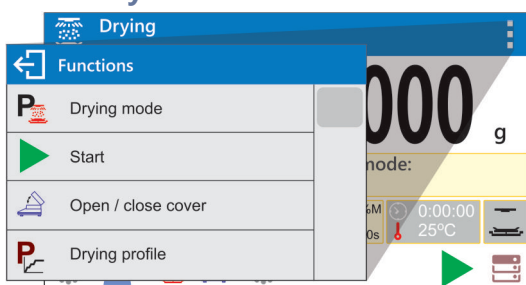

## Databases

Drying process can be carried out for any temperature and set for a specific product using following databases:

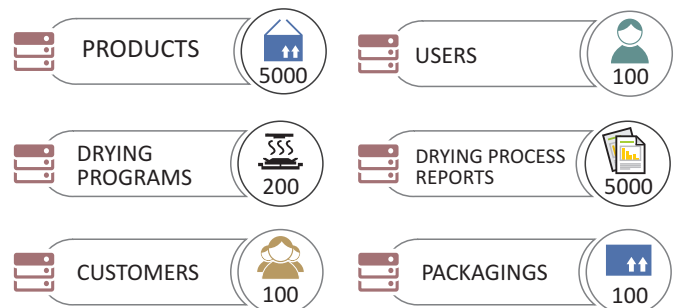

## GLP/GMP Printouts

An example of a printout

Information on drying parameters and moisture content result can be printed immediately using following elements: header – GLP – footer. Each of those elements can be customized in order to create a printout consistent with the requirements (GLP/GMP).

Drying process report	
Start date	2016.07.02
End date	14:24:02
Operator	John Smith
Product	Grain
Drying mode	Seeds
Drying parameters	
Drying profile	Standard
110 °C	
Finish mode	Automatic3
1mg/60s	
Indication	%M
Interval	30 s
Start mass	2,595 g
-----	
0:00:30	? 0,694%M
0:01:00	? 0,694%M
0:01:30	? 0,694%M
-----	
0:07:00	? 0,694%M
0:07:23	? 0,694%M
Status	Completed
End date	2016.08.03
End time	0:07:23
Drying time	14:24:02
End mass	2,315 g
Indication	10,790 %M

## DRYING FORECAST - Prognosis of the Drying Process Result

MBTD series moisture analyzers are now equipped with DRYING FORECAST function that enables to shorten the drying process. If you do not care about the highest accuracy and increased measurement error (ranging from 5% to 20% of the end value) you can shorten the drying process up to 6 times. It is an option dedicated for users who require fast and multiple estimation of materials moisture content.

DRYING FORECAST method is a prognosis of the end result, carried out before the drying process is completed.

Based on characteristics of current drying curve, created online, moisture analyzer estimates the end result of the drying process.

It is an approximate result characterized with small error of +/- 10% of the end result for most of the products and +/- 20% for products that require drying process to be longer (such as plastics, gels and materials containing more than 30% of water).

The calculation algorithm adapts to the drying material features and estimates first end result. The value of the prognosis is more accurate when the process takes more time. You can specify the time and accuracy of the process.

### Enabling Prognosis Function

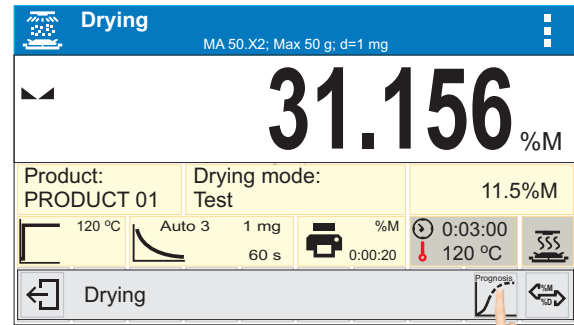

### Prognosis of the Drying Process Result

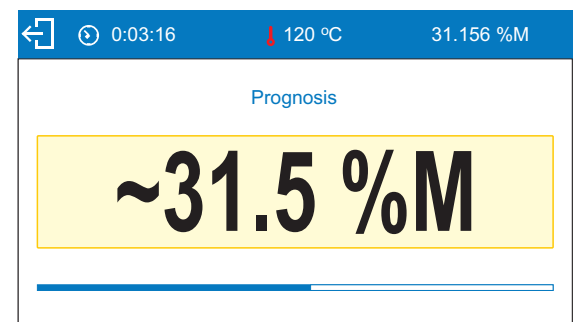

### Enabling drying forecast in the MBTD

By default, DRYING FORECAST function is disabled.

In order to enable it:

1. Select 'Settings' menu located in the left bottom corner of the screen

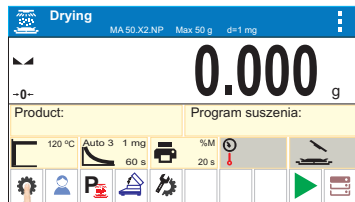

2. Select 'Working modes' submenu

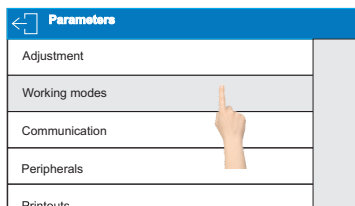

3. Select 'Drying' mode

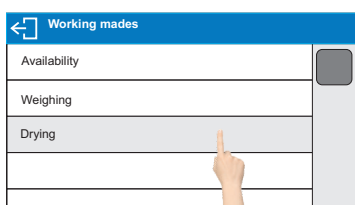

4. Use the scroll bar on the right to reach end of the menu

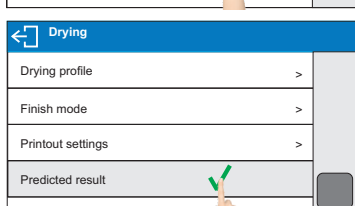

5. Enable DRYING FORECAST function by selecting 'Prognosis' parameter

### Drying Process Report Containing Prognosis

Drying process report	
Start date	2016.11.14
Start time	14:41:55
User	John
Product	PRODUCT 01
Drying mode	Test
Drying process parameters	
Drying profile	Standard
120°C	
Finish mode	Auto3
1mg/60s	
Indication	%M
Interval	20s
Start mass	0.796 g
-----	
0:00:00	0.000 %M
0:00:20	1.508 %M
0:00:40	7.412 %M
0:01:00	15.578 %M
0:01:20	21.859 %M
0:01:40	26.256 %M
0:02:00	29.020 %M
0:02:20	30.528 %M
0:02:40	31.030 %M
0:03:00	31.156 %M
0:03:16	31.156 %M
Status	Aborted
Drying time	0:03:16
End mass	0.548 g
Indication	31.156 %M
Predicted result	31.5%M

Signature

.....

## Technical specification:

	MBTD-50.H	MBTD-50	MBTD-110	MBTD-210
Max capacity	50 g	50 g	110 g	210 g
Readability [d]	0,1 mg	1 mg	1 mg	1 mg
Tare range	-50 g	-50 g	-110 g	-210 g
Max sample weight	50 g	50 g	110 g	210 g
Moisture readout accuracy	0,0001 %	0,001 %	0,001 %	0,001 %
Moisture content repeatability	0,05% (sample weight of 2 g), 0,01% (sample weight of 10 g)			
Max sample height	h= 20 mm			
Weighing pan size	Ø 90 mm, h= 8 mm			
Drying temperature range	max. 160° C			
Heating module	IR emitter			
Drying mode	4 drying modes (standard, quick, step, mild)			
Auto switch-off options	4 options (time-defined, automatic, manual, user-defined)			
Additional functions	Control of sample weight prior drying process			
Power supply	230 V			
Display	LCD 5" capacitive touchscreen			
Interface	1×RS 232, 1×USB-A, 1×USB-B, 1×Wireless Module			
Proximity sensors	2			
Net weight/gross weight	5,2 / 9,2 kg			
Packaging size	595×395×420 mm			

## Dimensions:

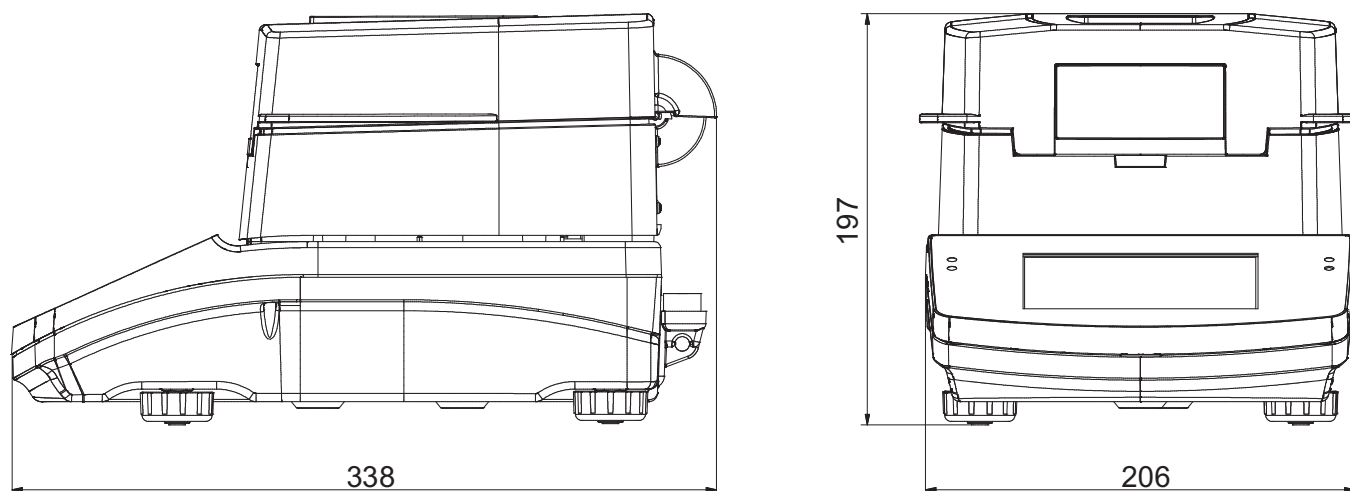

## Additional equipment:

Anti-Vibration Table (coated or stainless steel)	GT105k-12/Z Control Thermometer
EPSON Printer	Adjustment Weight
Disposable Weighing Pans	PW-WIN, RAD-KEY PC Software
PC Keyboard	Calbe RS 232 (balance - computer)
Water Vapour Permeability Determination Set	Cable RS 232 (balance - Epson printer)

**SCHULER SCIENTIFIC**

2860 So. Vallejo St., Unit B - Englewood - CO - 80110  
 Phone: 1-800-539-1886 • <http://schulersci.com> • e-mail: [info@schulersci.com](mailto:info@schulersci.com)